

 National
Neighborhood
Watch Program

Preventing Burglaries— How to Protect Your Home

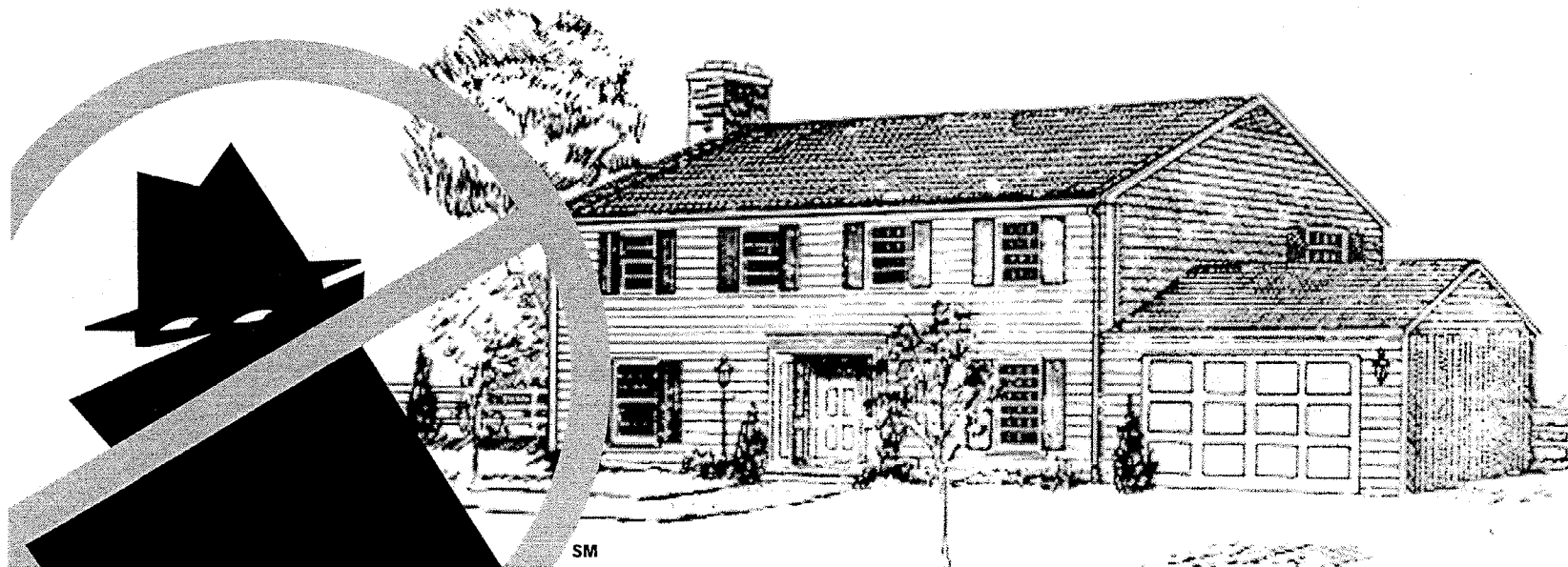

Crime continues to be a major concern of both citizens and their law enforcement agencies, although the alarming increase in crime in America in recent years appears to be leveling off.

Since 1990, national trends show burglaries down 32 percent. A large part of the credit for this encouraging news can go to an effective idea which is available to citizens nationwide: the National Neighborhood Watch Program.

The National Neighborhood Watch Program is designed to involve individual citizens in the crime prevention process. It was organized in 1972 by the National Sheriffs' Association in response to the requests of several national law enforcement groups to develop a crime prevention program based on citizen participation.

When citizens take positive steps by learning how to secure their property and report suspicious activities around their homes, they are helping themselves as well as their neighbors.

Neighborhood Watch focuses on the prevention of residential burglary.

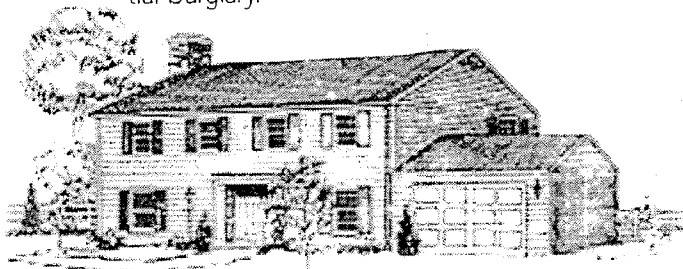

Here's why:

The estimated 2.1 million burglaries committed in the United States in 1999 account for approximately 18 percent of reported serious crime. Two of every three burglaries in 1999 were committed in houses, apartments, or other residential dwellings. The majority of residential burglaries (60 percent) occurred during daylight hours, while non-residential burglaries occurred primarily at night.

Burglary is expensive to the victim. In 1999, while the average loss for both residential and non-residential property burglaries declined from the previous year, victims still experienced an estimated total loss of \$3.1 billion. The average dollar loss per residential burglary was \$1,441.00, and for non-residential burglaries, \$1,490.00.

About 64 percent of all burglaries required forcing a door or window to gain entry. Most houses and apartments are protected by simple and relatively ineffective door and window locks. Modern hardware is available for these locks which will stop the amateur and slow up the experienced burglar. In communities of every size during 1999, the number of burglaries and the financial loss to the victims point to the continued need for vigilance.

Target hardening, or protecting vulnerable areas of your home and property by means of physical security devices, is an excellent starting point for reducing the likelihood that your house or apartment will be burglarized.

Remember the three D's of burglary prevention:



Deter — Sound residential security practices and good locks are a deterrent since they eliminate the opportunity for an easy burglary.



Detect — The possibility of detection is increased if you can force a burglar to work where he can be observed. A burglar also wants to avoid drawing attention to himself by making noise, such as breaking glass or smashing doors. Alarms on doors and windows are the surest way to detect a burglar, but watchful neighbors alert to unusual activity who will notify law enforcement authorities are also an effective means of detection.



Delay — Delaying a burglar for four minutes is generally considered sufficient to prevent entry into a residential dwelling. A burglar wants to avoid being caught, so the longer it takes to force a door or window, the greater his risk. It is nearly impossible to make a house or apartment impregnable, but it is relatively easy and inexpensive to make forced entry difficult and to delay the burglar.

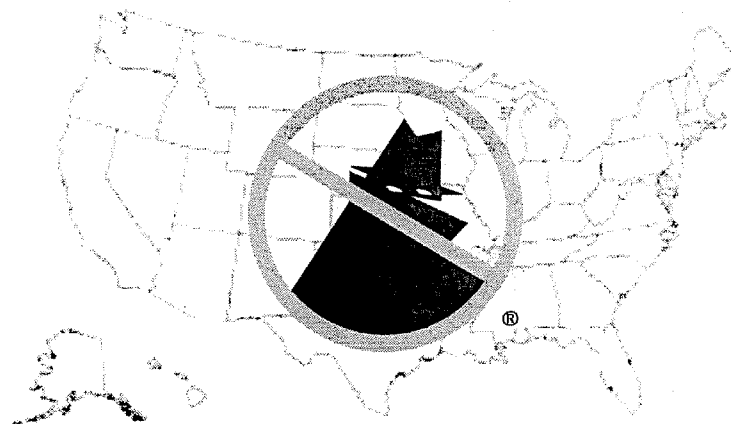

By keeping in mind the principles of deterrence, detection, and delay, you will be more likely to deny the burglar access to his target.

This booklet is designed to aid you in inspecting your home for security. Take time to put your own house in order. Then talk to your neighbors about how you can help each other keep your entire neighborhood safe.

If you want advice or assistance for your own house or for your neighborhood, your local law enforcement agency is ready to help.

You don't have to be one of the two million residential burglary victims and neither do your neighbors. Remember — crime prevention begins at home.

DOORS

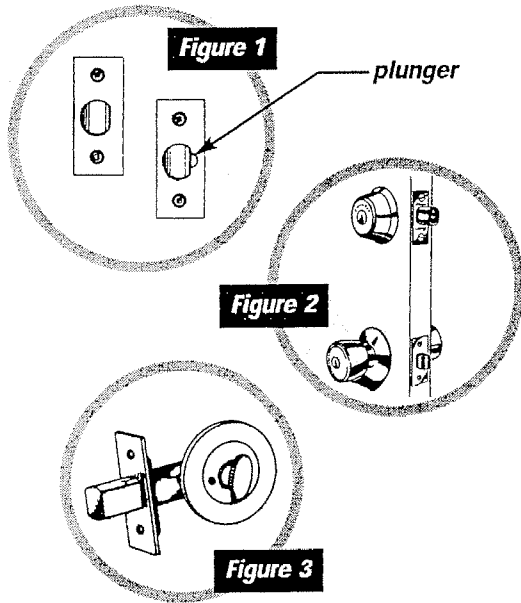



Figure 1

plunger

Figure 2

Figure 3

HINGED DOORS

 The most common door type in houses and apartments for use in front entries, porch doors, and doors from garages and basements into the living area of a residence is the hinge door. It is important that all exterior hinge doors be of solid core construction (1 3/4" thick if made of wood) or metal clad. Hollow-core or composition board doors can easily be battered or bored. When checking the security of your doors, the door itself, as well as the hinges, locks, and other hardware, must be considered.

LOCKS FOR HINGED DOORS

The most frequently used lock for hinge doors is the key-in-the-knob latch lock. For all key-in-the-knob locks, a dead-latching plunger type is recommended. (Figure 1)



Since key-in-the-knob locks can be forced by breaking off the knob, or opened by prying or slipping a piece of plastic between the jamb and the bolt, all exterior door locks of this type should be supplemented by the addition of a deadbolt. (Figure 2)



If there are no glass panels in the door itself or within 40 inches of the locking mechanism, doors can be equipped with a single cylinder deadbolt lock with a one-inch throw. The lock is key-operated from the outside, and is operated from the inside by a thumb turn. (Figure 3)



When installing a deadbolt, attach the strike plate to the door with three-inch screws. The screws should penetrate through the frame to the structure.

If your door has glass panes or if there are windows within 40 inches of the lock, a double cylinder deadlock is recommended. (Figure 4) Double cylinder deadbolt locks are key-operated from both the inside and the outside.

The jimmy-proof deadbolt lock (Figure 5) can be used on any hinge door where the strike can be securely fastened to the door frame. These locks come in both double cylinder and inside thumb-operated models.

PINNING HINGED DOORS

 If your door hinges are located on the outside of the door, non-removable hinge pins should be used. There is also a simple way to prevent removal of a door if hinge pins have been extracted. Insert headless screws into the back edge of the door midway between the hinges. Drill an opposing hole in the door jamb to receive the screw when the door is closed. (Figure 6)

Doors with glass panels may require special treatment such as security screening or decorative grilles securely mounted using non-removable screws. (Figure 7) Another alternative is to reinforce the glass with clear acrylic plastic or polycarbonate sheeting to prevent it from being shattered. Doors from the garage or the basement into the main living area of the house should be of solid core construction and equipped with secure locks.

 For solid panel exterior doors, a viewer is recommended. (Figure 8)

Figure 4



 Special care must be taken to allow for emergency exit. Occupants must have easy access to keys.

Figure 5

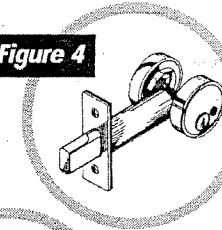
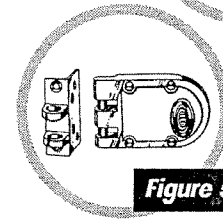
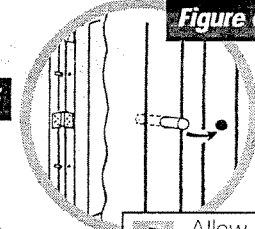

Figure 6



 Allow headless screw to protrude approximately 1/2 inch.

Figure 7

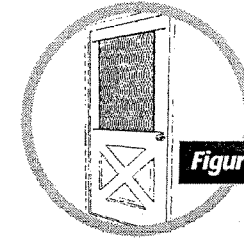
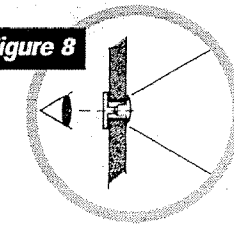
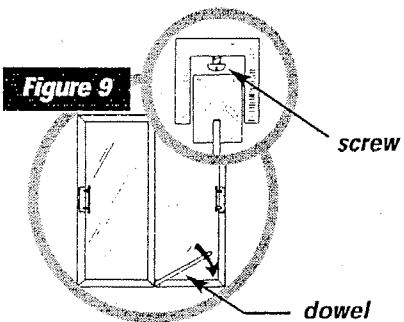

Figure 8





SLIDING GLASS DOORS

Sliding glass doors present a major security problem if they do not have the proper locks, and if special steps are not taken to prevent removal of the door. An inexpensive security measure involves placing a dowel in the bottom track to prevent the door from being pried open. (Figure 9)



A sliding glass door is lifted into position when installed and, therefore, can be lifted from the track to be removed by a burglar. To prevent this, it is recommended that two or three sheet metal screws be inserted into the track above the sliding door. These screws should be adjusted so that the top of the door barely clears them when it is operated. (Figure 9)

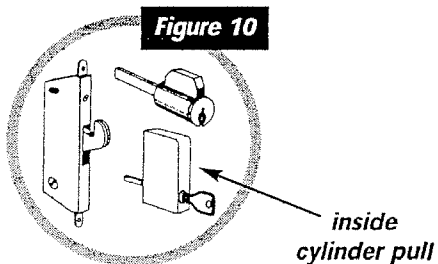

The best lock for a sliding glass door is a deadlock, which utilizes a bore pin tumbler cylinder and is operable by a key from the outside. The lock bolt should engage the strike sufficiently so that it will not be disengaged by any amount of movement. When the existing inside pull has to be changed in order to accommodate a new deadlock, an inside cylinder pull is recommended as a replacement. (Figure 10)



CRIME PREVENTION BEGINS AT HOME

Front Entrance — All front entrance doors should be metal clad or of solid core wood construction. A deadbolt lock, in addition to the key-in-the-knob lock, is essential. Use a wide-angle viewer rather than a door chain to observe callers. A screen door or storm door offers additional protection if kept locked.



Ground Floor Windows — All ground floor windows should have key-operated sash locks or other locks as described in this booklet. Keep your windows closed and locked when you are away. Screens and storm windows should be securely fastened to the structure.



Upper Floor Windows — Keep your second floor secure by trimming tree branches away from the house to prevent access, and do not store ladders where a burglar can use them. Lock all windows while you are away. Take the same precautions as with ground floor windows.



Basement Windows — Close and lock your basement windows. If they are not required for ventilation or emergency exit, they should be permanently secured by using nails through the window frame into the structure.



Garage Door — The garage door should always be closed and locked. Treat the entrance door from the garage to your house the same as an exterior entrance. A burglar in your garage can work on your house door undetected.



Porch and Patio Doors — Treat all exterior doors on the rear and sides of your home as possible targets for entry. Since they may be less observable from the street and by neighbors than a front entrance, extra precautions may need to be taken.

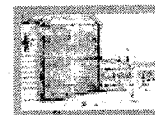

Yard Lights — Each exterior entrance, including the garage door, should be well lighted. Post lights in your yard or floodlights mounted under the eaves to prevent blind spots where burglars can hide. Low cost controls for exterior lights will turn them on and off at specified times, or motion-sensor lighting can be installed.



Interior Lights — When you are away from home, whether on vacation or just for the evening, keep some interior lights burning. To create the appearance that someone is at home, use a timer to turn lights on and off at normal times. A radio playing adds to the illusion that the house is occupied.



Landscaping — When placing trees, bushes, and flowers, remember to keep doorways, windows, and porches clear. Remember that the bushes that provide you with privacy also give a burglar a place to hide. Plan your landscaping with both privacy and security in mind.



Be Neighborly — Share with your neighbors your concern about burglary. Tell them what you are doing to protect your home. Ask them to report any suspicious persons or activities around your home to your law enforcement agency. Good neighbors make safe neighborhoods.

WINDOWS

DOUBLE HUNG SASH WINDOWS

Double hung sash windows, which operate upward and downward, usually have simple crescent latches which can easily be jimmed. The most effective protection for double hung windows is a key-locking security sash lock. (Figure 11) These should be mounted with two-inch or three-inch screws. Storm windows and screens offer some additional protection.

For extremely vulnerable windows, heavy-gauge metal ornamental grilles may be used. (Figure 12) Grilles should be attached with non-removable screws or fastened from the inside.

Pinning double hung sash windows provides an inexpensive and effective solution. Pinning can be accomplished by drilling holes at a downward angle in each top corner of the inside sash, and entering the outside sash. The window can then be secured by inserting nails through the holes which prevent it from being raised. (Figure 13)

SLIDING, CASEMENT, AND JALOUSIE WINDOWS

 Protect all of your windows. Remember that second floor and basement windows are as important as first floor windows. Screens and storm windows are always an asset if properly secured.

Sliding windows, either metal or wood frame, should be protected in the same way as sliding doors. Wooden dowels laid in the track and screws set in the track to prevent the window from being lifted out are effective protective measures.

Figure 11

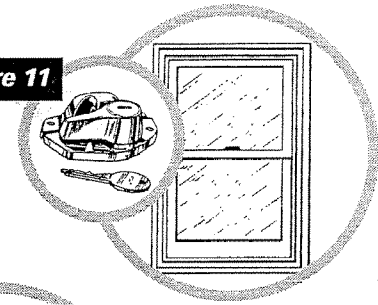

Figure 12

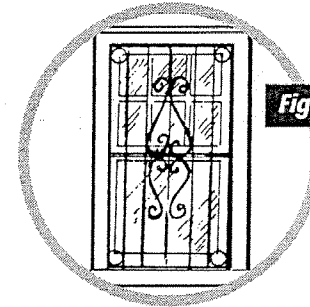
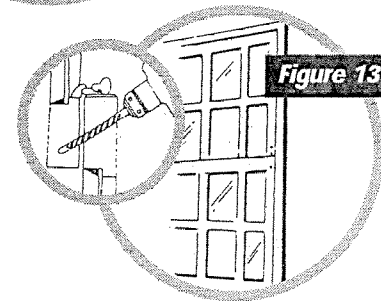

Figure 13



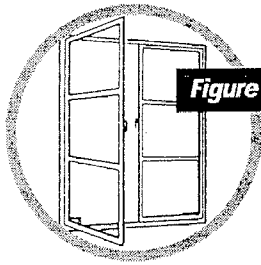

Figure 14

Casement windows generally open and close by means of a gear operating handle and have a locking device which secures the window to the center post. (Figure 14) Some protection is offered by removing the crank handle from the opening mechanism when away from home. Do not leave casement windows partially opened as they can then be easily forced.



Jalousie (louvered) windows are a high security risk because individual slats are easily removed to allow access. (Figure 15) Jalousie windows should be replaced if possible, or a protective grille or screen should be added.

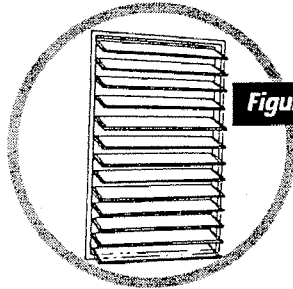

Figure 15

YARDS

✓ **Garages** — Garage doors are a possible means of entry to your house, as well as offering a burglar the opportunity to steal automobiles, tools, bicycles, and other property stored in the garage. Keep your garage door closed and locked.

✓ **Walks and Driveways** — Walks and driveways should be kept free from offering concealment to intruders.

✓ **Gates and Fences** — While offering possible concealment to burglars, gates and fences properly used can also deter the removal of large items and increase the difficulty of breaking in.

✓ **Prune Large Trees** — Low limbs can provide second story access.

✓ **Lawn Care** — A well-manicured lawn provides an effective clue that someone is at home and cares.

✓ **Trim Shrubs** — Deny burglars a hiding place to work — don't block the view. Permit ready visibility by neighbors and police.



✓ **Alarms** — Residential burglar alarms are available from electrical and hardware dealers, as well as entire systems that may be leased or purchased from alarm companies. Most residential alarms emit a loud noise from a bell, siren, or tone generator. An audible alarm on doors and windows can be an effective deterrent to the amateur burglar. If you do install an audible alarm, make sure that your family and your neighbors are informed about its function and that they are trained to call your law enforcement agency when they hear the alarm. Your law enforcement agency should be consulted when you install an alarm.

LIGHTS

Exterior lighting is extremely important in residential security. Each exterior doorway should be lighted to prevent a burglar from concealing his activities. Yards and areas around windows should be lighted to prevent concealment. A number of ornamental porch lights and lamp post lights are available which can help eliminate night blind spots. (Figure 16)

Yard lights and entrance lights can be equipped with sensors which will turn the light on at dusk and off at dawn. Motion sensor lighting can also be installed that will activate when a person walks past or some other movement takes place. (Figure 17)



To give the appearance that you are at home, use an electric timer to turn lamps on in the evening and off at your normal retirement hour. (Figure 18)
Timers can be used to turn on radios as well as lamps. Use at least one timer on each floor of the house.

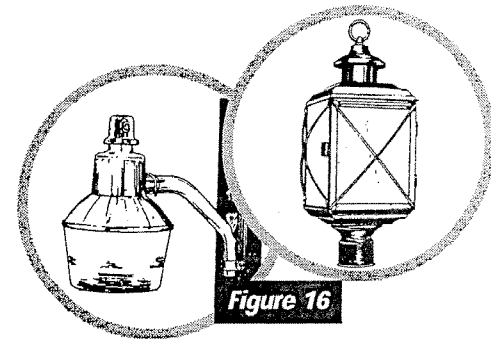

Figure 16

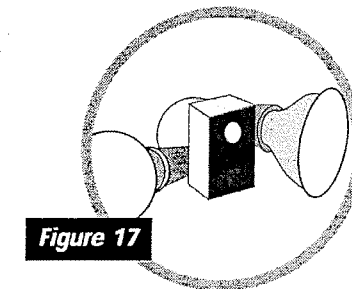

Figure 17

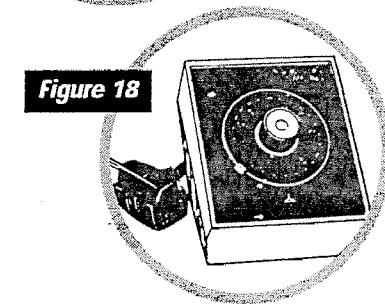

Figure 18

